

PIPETMAN® *Ultra* *Multichannel*

ENGLISH



 **GILSON**®
SOLUTIONS AT WORK FOR YOU



CONTENTS	page
1 - INTRODUCTION	2
2 - PARTS CHECK LIST	3
3 - DESCRIPTION	4
4 - SWITCHING ON	5
5 - VOLUME INDICATOR - LCD WINDOW	6
6 - SETTING THE VOLUME	7
7 - GILSON DIAMOND [®] TIPS	8
8 - PIPETTING	10
9 - PERSONALIZING YOUR PIPETTE	12
10 - GLP FEATURES	13
11 - TROUBLESHOOTING	14
12 - MAINTENANCE	15
13 - CLEANING AND DECONTAMINATION	22
14 - LEAK TEST	24
15 - RECALIBRATION (USER ADJUSTMENT)	25
16 - SPECIFICATIONS	27
17 - SPARE PARTS	28

1 - INTRODUCTION

Congratulations on acquiring your new Pipetman Ultra Multichannel. Enjoy the following features.

Easy of use:

- Continuously-adjustable parallax-free electronic display for easy volume setting,

- Flashing indicators if volume set is out of range,
- Ergonomic design, maximum comfort for left or right-hand users,
- Low tip-ejection force, no need to handle tips,
- Simple to maintain and adjust,
- Other GLP features.

Performance:

- Accurate and precise,
- Unbeatable results with Gilson Diamond Tips,
- Easy and secure tip loading from Gilson Tipacks.

Applications:

- Multichannel (8 or 12): designed for use with plates (96-well and upwards).
- Molecular studies, kinetic studies, DNA sequencing, enzyme-assays, and the measurement and transfer of general aqueous solutions.

2 - PARTS CHECK LIST

Just take a moment to verify that the following items are present:

- Pipetman Ultra Multichannel pipette,
- Certificate of conformity (including bar-code sticker).
- User's Guide,
- Identity tags (5 different colors),
- Safety bag,
- Recalibration (user adjustment) tool,
- Tip-holder reassembly tool,
- Tube of lubricant.

3 - DESCRIPTION

- 1) Push-button for switching on, setting the volume, aspirating, and dispensing. (Button is color coded with the volume range printed on the top.)
- 2) Ergonomic stabilizer, to make the pipette more comfortable to use, and to reduce fatigue.
- 3) Thumbwheel, to set and lock the volume.
- 4) Tip-ejector button, can be positioned for left or right-handed operation.
- 5a) Liquid Crystal Display (LCD) window for volume-setting and status indicators.
- 5b) Identity-tag window (see “GLP features”).
- 6) Connecting nut - links body to the head (box containing pistons and tip-holders).
- 7) Tip-ejector stroke adjustment-wheel.
- 8) Tip-holders - removable for cleaning and servicing.
- 9) Plastic cover-ejector: removable to access piston assemblies and tip-holders.

Table - Operating Ranges

Model	Reference	Tips	Range	Color code
8x20	F21040	DL10	1 μ L to 20 μ L	Pale yellow
12x20	F21041	DL10	1 μ L to 20 μ L	Pale yellow
All	-	D200	-	
8x300	F21042	D300	20 μ L to 300 μ L	Green
12x300	F21043	D300	20 μ L to 300 μ L	Green

 *Gilson recommends that you use Diamond Tips with Pipetman Ultra Multichannel. For reasons of quality, Diamond Tips are manufactured under strictly controlled conditions.*

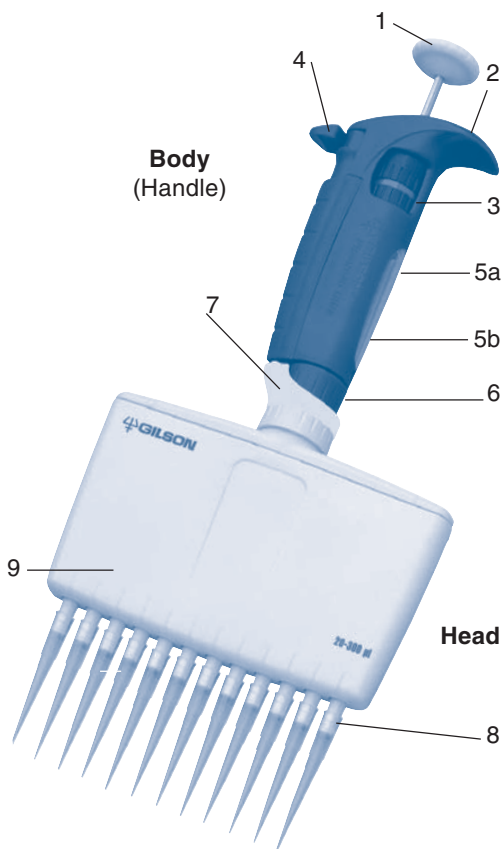

4 - SWITCHING ON

Press the push-button to the first stop to switch on the pipette. The information displayed in the LCD window depends on the status of the pipette and the volume currently set (see below).

 *Pipetman Ultra Multichannel turns itself off after 3 min of inactivity - just press the push-button (or unlock) to reactivate the pipette.*

5 - VOLUME INDICATOR - LCD WINDOW



What you normally see...

- 1) Volume setting
- 2) Units (μL)
- 3) Volume status (locked or unlocked)

What may appear...

- 4) Calibration status: "RECAL" this pipette has been adjusted by the user.
- 5) Battery status: failing - "LOW BATT" here, or failed - "BATT" in place of volume setting. (The battery is factory installed. It has a lifetime of four years under normal use.)
- 6) Cycle counters:

You will see the counters at the right-hand side of an otherwise blank screen.

 - a) Since the last volume setting - holding down (fully) the push-button for 7 seconds displays this information (maximum 199); for example 126 cycles.
 - b) Since the pipette was made - holding down (fully) the push-button for 10 seconds displays this information (maximum 999999); for example 285396 cycles.
- 7) Refer to "Troubleshooting" for possible error messages.

A rectangular box containing the number '126' in a digital font.

A rectangular box containing the number '285396' in a digital font.

6 - SETTING THE VOLUME

You must perform the following steps:

- 1) Switch on: press the push-button to the first stop. LCD shows the volume currently set.
- 2) Unlock: push the thumbwheel upwards. LCD shows UNLOCKED (also visible on the thumbwheel).
- 3) Set the volume: rotate the thumbwheel or the push-button (clockwise to decrease the volume, counterclockwise to increase):
 - when **decreasing** the volume, reach the required setting slowly, making sure not to overshoot the mark.
 - when **increasing** the volume, pass the required value by 1/3 of a turn, then decrease the volume slowly, making sure not to overshoot the mark.
- 4) Lock the volume by pushing the thumbwheel downwards. LCD shows the volume set and LOCKED.

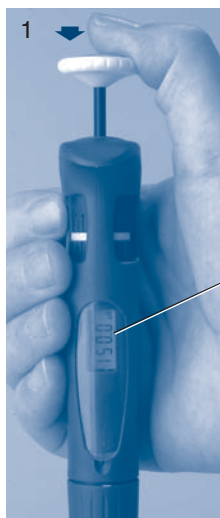

2 To unlock



3 LCD



4 To lock

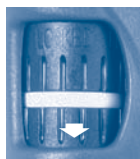

- 1) *You are strongly advised to lock the volume, to avoid accidentally changing the setting when pipetting.*
- 2) *To reduce battery consumption, lock the volume before storing Pipetman Ultra Multichannel.*
- 3) *The units indicator flashes, if you set a volume below 90 % of the minimum recommended; you can dispense an aspirated volume below the minimum recommended. However, in this case, the specifications cannot be guaranteed.*
- 4) *The volume indicator flashes, if you try to set a volume above the maximum permitted; you must not try to pipette a volume that is greater than the maximum permitted.*

Volatile Solvents

For volatile solvents you should saturate the air-cushion of your pipette by aspirating and dispensing the solvent repeatedly before aspirating the sample.

7 - GILSON DIAMOND TIPS

You should use Diamond Tips, which are made to the highest specifications; strict quality control is maintained throughout the manufacturing process.

Diamond Tips are used to calibrate Pipetman Ultra Multichannel, therefore for optimum performance, you are strongly advised to use Gilson's Diamond Tips with your pipette. Diamond Tips have the Gilson logo engraved on their collar, ensuring that you have a genuine Gilson product. To ensure accuracy and precision, Gilson's Quality Assurance System focuses on the following critical parameters.

- Diamond Tips are made from pure polypropylene (virgin, metal-free, to avoid the possibility of contamination). They are available sterilized and with filters.
- Optimized shape (revised collar for optimum sealing, thin walls, and fine point), making them easier to mount, more flexible, with no vortexing, and improved precision.
- Diamond Tips are free from defects, especially at the orifice. All surfaces are smooth and hydrophobic, thereby avoiding the excessive retention of liquids that causes poor accuracy and a lack of precision.
- Mold and cavity references are marked on the collar, ensuring the traceability for quality assurance purposes, batch numbers appear on all packages (bags and boxes).

Gilson
Logo

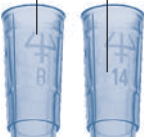

ID Number
- They form an airtight seal with the tip-holder, preventing the leaks that cause poor accuracy and a lack of precision.
- They may be autoclaved at 121 °C for 20 minutes at 0.1 MPa.

Tipack - Rocky Rack

Diamond Tips are best fitted from a Rocky Rack (patented). Rocky Rack is the dome-shaped part of the pack that contains the tips. Rocky Rack makes it easy to securely fit the tips to a multichannel pipette, ensuring an airtight seal on all channels without the need to use undue pressure or to touch the tips.



8 - PIPETTING

1) Optionally, set the head to any position that is comfortable and practicable for your application. To do this, simply turn the head to the desired position.

2) Fit new Diamond Tips from a Tipack™. To do this, push the tip-holders simultaneously into the racked Diamond Tips, use a back-and-forth or a side-to-side rocking motion to ensure that the tips are securely fitted, then withdraw the pipette with the tips.

 *You must fit tips to your pipette before aspirating and dispensing any liquid. Plastic tips are for a single application - they must not be cleaned for reuse.*

3) Pre-rinse the tips.

Some liquids (e.g. protein-containing solutions and organic solvents) can leave a film of liquid on the inside the wall of the tip; pre-rinse the tip to minimize any errors that may be related to this phenomenon. Pre-rinsing consists of aspirating the first volume of liquid and then dispensing it back into the same vessels (or to waste). Subsequent volumes that you pipette will have levels of accuracy and precision within specifications.

4) Aspirate.

Press the push-button to the **first stop** (this corresponds to the set volume of liquid).

Hold the pipette vertically (+/- 20°) and immerse the tip in the liquid (2 mm to 4 mm).

Release the push-button slowly and smoothly (to **top** position) to aspirate the set volume of liquid.

Wait one second then withdraw the pipette-tip from the liquid.

You may wipe any droplets away from the outside of the tip using a medical wipe, however if you do so **take care to avoid touching the tip's orifice.**

5) Dispense.

Place the ends of the tips against the inside walls of the recipient vessels (at an angle of 10° to 40°).

Press the push-button slowly and smoothly to the **first stop**.

Wait for at least a second, then press the push-button to the **second stop** to expel any residual liquid from the tips. Keep the push-button pressed fully down and (while removing the pipette) draw the tips along the inside surface of the vessel.

Release the push-button, smoothly.

6) Eject the tips by pressing firmly on the tip ejector button.

 *The tip ejector stroke can be set to allow for different types of tip, where (for example) the length of the collar is different (refer to “Personalizing Your Pipette”).*



General Guidelines for Good Pipetting

- 1) Make sure that you operate the push-button slowly and smoothly.
- 2) When aspirating, keep the tips at a constant depth below the surface of the liquid (2 mm to 4 mm).
- 3) Change the tips before aspirating a different liquid, sample, or reagent.
- 4) Change the tips if droplets remain at the end of the tip from the previous pipetting operation.
- 5) The tips should be pre-rinsed with the liquid to be pipetted.

- 6) Liquid should never enter the tip-holders; to prevent this:
 - press and release the push-button slowly and smoothly,
 - never turn the pipette upside down,
 - never lay the pipette on its side when there is liquid in any of the tips.
- 7) When pipetting liquids with temperatures different to the ambient temperature, pre-rinse the tips several times before use.
- 8) Avoid pipetting acids or other corrosive liquids that emit vapors. Extensive contact with corrosive fumes may corrode the pistons or damage the seal and tip-holders.
- 9) Do not pipette liquids having temperatures above 70 °C or below 4 °C.

 *The use of a Gilson "Carrousel™" or "Trio™" to store pipettes in the vertical position is recommended.*

 **Extreme temperatures can affect accuracy and precision.**

9 - PERSONALIZING YOUR PIPETTE

Comfort of Tip-ejector

Before you start to pipette you can adjust the tip-ejector mechanism according to your preferences.

- 1) Position the tip-ejector button. Simply rotate the tip ejector button to the most comfortable position: left, right, or middle.

Tip-ejector Button
(set for right handed user)



- 2) Set the stroke by rotating the adjustment wheel until you find the position where it is most easy to activate the tip ejector.

You may want to reset the stroke after fitting a different type or size of tip.



Head Position

You can adjust the position of the head to suit your needs. Simply rotate the head relative to the body of the pipette. Normally, you would set the head either parallel to or at 90° to the body, but you can choose any position between the two. Remember to check that the connecting nut is tight after adjusting the head position.

Personal Label - Name Tag

You can identify your pipette with a name tag:

- 1) Pry out the window by inserting a small screwdriver in the access slot.
- 2) Position the name tag next to the LCD.
- 3) Clip the window back into place.

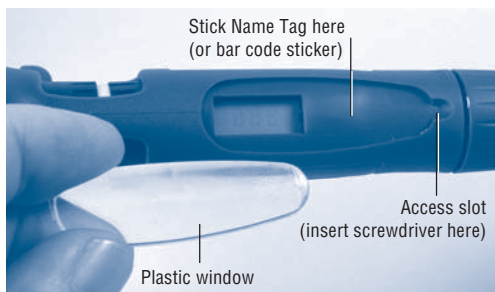

10 - GLP FEATURES

There are as follows:

- Locked volume.
- Serial Number: engraved on body of the pipette and is encoded in the bar-code.

- Bar Code: on the box and with the certificate (can be transferred).
- Name Tag (Application or User).
- Cycle counters:
 - from last volume setting (to count the number of cycles in the current “run”),
 - from manufacture (to count the number of cycles for servicing purposes).
- Flashing display when volume set is out of specifications.
- Indicator when pipette has been recalibrated (adjusted by the user).
- Channel number embossed on the head of each pipette.
- Useful volume-range is printed on the push-button and the cover-ejector.

11 - TROUBLESHOOTING

You may be able to identify and to correct the problem by reference to the following table.

Symptom	Possible Cause
Pipette is leaking sample (one or more channels)	Damaged tip-holder(s) Damaged O-ring.
Pipette won't aspirate	Damaged O-ring. Damaged tip-holder(s). Connecting nut is loose. Damaged or corroded piston. Improper repair or assembly.
Noisy operation	Piston(s) needs lubricating.
Pipette is inaccurate	Improper repair or assembly. Pipette is out of adjustment. Connecting nut is loose.
Pipette is not precise	Connecting nut is loose. Volume setting not locked. Incorrect operator technique. Damaged or corroded piston(s). Damaged tip-holder(s). Damaged O-ring.

Symptom	Possible Cause
Tips fall off or don't fit	Low quality tips. Damaged tip-holder(s). Incorrectly set tip-ejector stroke adjustment
No LCD display	Pipette is not switched on. Battery has failed.



Before returning any pipette, ensure that it is completely free of chemical, biological, or radioactive contamination. Use the safety bag provided by Gilson.

Error Messages

If any of the following occur, contact your Gilson distributor.

Message	Cause
ERR1	Battery was changed when the pipette was in the unlocked position. Volume was not set to the correct calibration volume when the user calibration tool was plugged in.
ERR2	Setting problems.
ERR3	Electronic problems (microchip).

12 - MAINTENANCE

You may perform the following:

- clean or autoclave the parts specified under “Cleaning and Decontamination”,
- replace the parts specified under “Spare Parts”,
- lubricate the pistons,
- change the battery,
- recalibrate (user adjustment).

The two main parts of the pipette are the head and the body (handle). The head contains the components that could be in contact with liquids (tip-holders, pistons, etc...).

The body contains electrical and mechanical components that must not be in contact with liquids.

The head of the pipette contains the tip-holders and the piston assemblies - to service these items you must first remove the plastic cover-ejector, which also may be cleaned or replaced.

 *A connecting nut joins the head to the body. You should not fully undo the connecting nut. If the connecting nut becomes loose, turn it clockwise until fully tight. This action may be necessary after adjusting the position of the head.*

Removing the Plastic Cover, Piston Assemblies and Tip-holders

- 1) First set the pipette to its minimum volume.
- 2a) Remove the two screws, which are located at either side of the head, using a miniature screwdriver.

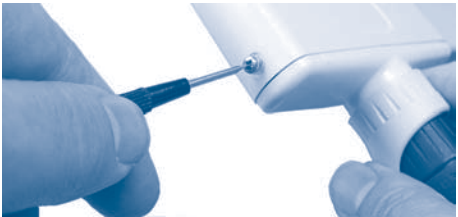

- 2b) Gently pull the cover-ejector away from the head.

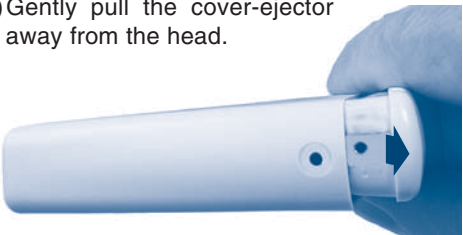

- 3) Remove the wire clip (8 channel models) or clips (12 channel models) from the piston tray-cover.

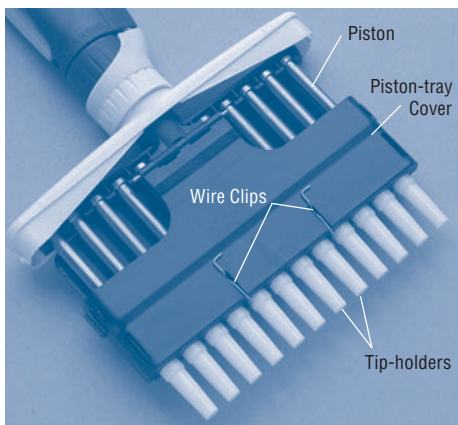

- 4) Lay the pipette flat and push awards (with your thumbs) on the catches at either side of the piston-tray cover. The cover will flip upwards to reveal piston and tip-holder assemblies.



- 5) Lift the tip-holder upwards, away from the lower rake, then push the tip-holder back along the axis of the piston. Now, pull the piston away from the upper rake and lift it and the tip holder out of the tray, taking care not to lose or damage the piston spring.
- 6) Gently pull the piston assembly out of the tip-holder.

Servicing the Cover-ejector, Piston Assemblies and Tip-holders

The tip-holders and piston assemblies must be changed, if they are accidentally damaged or attacked chemically. You should also remove them for cleaning or decontamination purposes, and to lubricate the pistons.

- 1) Examine the cover-ejector, if it is cracked or badly corroded it should be replaced with a new part. Otherwise, it should be cleaned and if necessary autoclaved.
- 2) Check the piston for damage or corrosion. Lubricate and replace as necessary.
- 3) After removing the locking clip, gently pry out each tip-holder's internal components: locking-clip, spring, O-ring and seal-holder - this can be done using the reassembly tool. Replace or clean and decontaminate these components. Replace or clean and decontaminate the tip-holder.

 *The O-ring can get trapped in tip-holder. Use a fine plastic probe to extract the O-ring.*

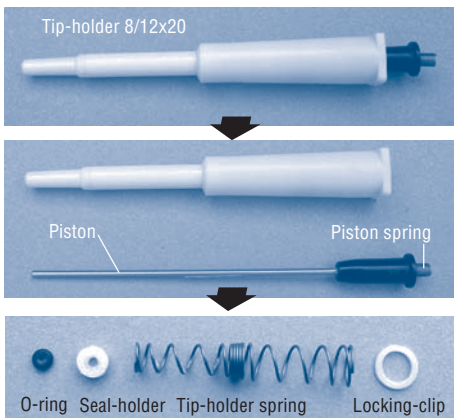

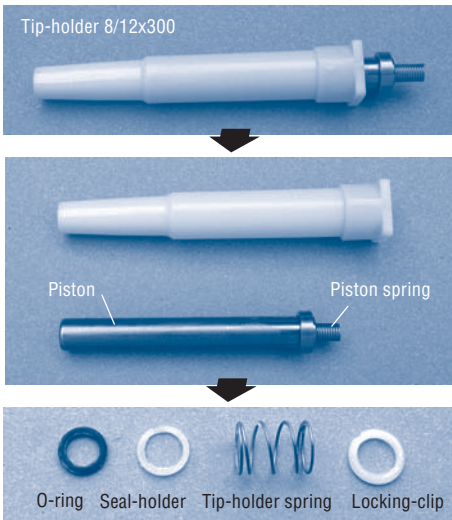

How to Lubricate Pistons

Only use Gilson lubricant (ref: F2070902, as supplied). Squeeze a small quantity from the tube onto a clean, nonabrasive cloth. Use the cloth to transfer the lubricant to the piston. Ensure that the piston is evenly lubricated, and that you wipe away any excess - remember only a fine film of lubricant is required (over the entire piston).

Reassembling the Piston Assemblies, Tip-holders, and Plastic Cover-ejector

A) Tip-holders

- 1) Use a lubricated piston to transfer a small quantity of lubricant to the O-ring.
- 2) With reference to the photo's below, place the components on the reassembly tool in the following order: locking-clip, tip-holder spring, seal-



holder, O-ring - take care that the spring is the correct way up.

- 3) Insert the components into the tip-holder with the aid of the reassembly tool.

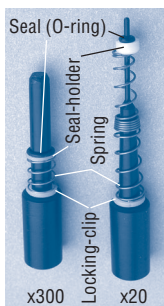

- 4) Push on the locking-clip until it snaps into place.

B) Piston Assemblies

- 1) Lubricate the piston, as described in the section above.
- 2) Gently, slip a lubricated piston into the tip-holder, with a slight twisting motion. Avoid using too much force as this could dislodge the O-ring.



C) Closing-up

- 1) Refit each tip-holder/piston assembly so that the top of the piston and the tip-holder snap into the upper and lower rakes, respectively. To facilitate fitting a piston assembly to the upper rake, you should incline the piston assembly and compress the piston-spring against the upper rake, before pushing the assembly into place.
- 2) Close the piston tray-cover, after checking that all assemblies are correctly installed.
- 3) Refit the wire-clip(s).
- 4) Slide the cover-ejector back over the piston-tray and reattach using the two screws.

Changing the Battery

The battery is a silver-oxide plated 1.5V generic code 386 (size 11.6 x 4.2 mm).

- 1) Remember that locking your pipette when not in use will maximize the life of the battery.
- 2) Although changing the battery does not affect the calibration, you may wish to take this opportunity to perform a user adjustment (recalibration) of the pipette.

Battery life under normal use is 4 years. If you need to change it proceed as follows:

- ensure the pipette is in the locked position, remove the tip-ejector,
- remove the battery compartment cover,
- pull out the battery and holder (red plastic),
- lift up and remove the copper clip (refer to Figure),
- lever out the old battery and put it in a secure bin for recycling,
- insert a new battery (see spare parts) into the battery holder,
- refit the copper clip,
- reinsert the battery holder into the battery compartment
- refit the battery compartment cover.

Battery:
negative (-) terminal



Copper clip, lift here



Take care that the negative terminal of the battery is uppermost (ie facing you).

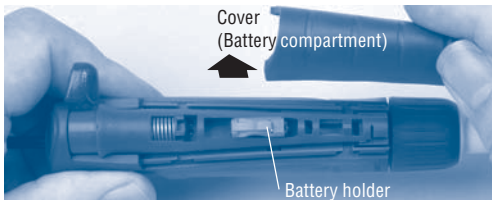

13-CLEANING AND DECONTAMINATION

Pipetman Ultra Multichannel is designed so that the parts normally in contact with liquid contaminants, can easily be cleaned and decontaminated.



Liquid must not enter the body (handle) of the pipette.

If you use chemical solutions for decontamination or detergents for cleaning, other than specified below, you should check with your supplier that the solution or detergent used does not attack any of the following materials: PBT (Polybutylene Terephthalate), PVDF (Polyvinylidene Fluoride), or stainless steel.

Cleaning

The pipette must be cleaned, as described below, before it is decontaminated. Soap solution is recommended for cleaning Pipetman Ultra Multichannel.

External

- 1) Wipe the entire pipette with a soft-cloth or lint-free tissue impregnated with soap solution, to remove all dirty marks. If the pipette is very dirty, a brush with soft plastic bristles may be used.
- 2) Wipe the entire pipette with a soft-cloth or lint-free tissue impregnated with distilled water.

Internal

The following components **only** can be immersed in a cleaning solution: cover-ejector, tip-holder, piston and springs.

- 1) Disassemble the pipette as described in "Maintenance".
- 2) Set aside the body (handle) in a dry and secure location.

- 3) Clean the individual components from the pipette head using an ultrasonic bath (20 minutes at 50 °C) or with a soft-cloth and brushes.
- 4) Rinse the individual components with distilled water.
- 5) Leave the parts to dry by evaporation or wipe them with a clean soft-cloth or lint-free tissue.
- 6) Lubricate the piston and reassemble the pipette according to the instructions given earlier in this chapter.

Decontamination

Autoclaving

The body (handle) of the pipette is **not** autoclavable. However, after separation from the body, the entire head may be autoclaved, as a unit. Also, any of the internal components may be autoclaved individually: cover-ejector, tip-holders, pistons, springs, O-ring, and washers.

- 1) Clean the parts to be autoclaved, especially the tip-holders.
- 2) Put the parts in an autoclaving sack.
- 3) Autoclave for 20 minutes at 121 °C and 0.1 MPa.
- 4) Check that the parts are dry before reassembling the pipette.
- 5) Set the pipette aside to stabilize at room temperature.

Chemical Decontamination

You may choose to decontaminate your pipette chemically, in accordance with your own procedures. Whatever decontaminant you use, check that it is compatible with the plastics used in the construction of the pipette (see page 22).

Body (Handle)

- 1) Wipe the body (upper part) of the pipette

with a soft-cloth or lint-free tissue impregnated with the chosen decontaminant.

- 2) Wipe the upper part of the pipette with a soft-cloth or lint-free tissue impregnated with distilled water or sterile water.

Head

The following components **only** can be immersed in a decontaminant solution: cover-ejector, tip-holder, piston, and springs. The O-ring, washer and washer clip should be replaced.

- 1) Disassemble the pipette as described in "Maintenance".
- 2) Immerse the components in the decontaminant solution or wipe them according to the instructions given by the manufacturer or supplier of the decontaminant.
- 3) Rinse the individual components with distilled or sterile water.
- 4) Leave the parts to dry by evaporation or wipe them with a clean lint-free tissue or soft-cloth.
- 5) Lubricate the piston and reassemble the pipette according to the instructions given earlier in this chapter.

14 - LEAK TEST

This test may be performed at any time to check that the pipette does not leak, especially after performing a maintenance or decontamination procedure. If a pipette channel fails this test you should replace the faulty part (e.g. O-ring, tip-holder...) and repeat this test, after making sure that the pipette is correctly reassembled.

- Fit a Gilson Diamond Tip to each tip-holder,
- set the pipette to the nominal volume (300 μ L or 20 μ L).

- pre-rinse the tips as you would in normal use (see “Pipetting”)
- aspirate the nominal volume of distilled water all channels simultaneously,
- hold the pipette in the vertical position and wait for 20 seconds,
- if a water droplet appears at the end of the tip there is a leak,
- if you see no droplet, re-immerses the tip below the surface of water,
- the water level inside the tip should remain constant; if the level goes down there is a leak.

15 - RECALIBRATION (USER ADJUSTMENT)

The following procedure is primarily used to check the accuracy of a pipette following servicing (for example, after replacing the piston assembly). Recalibration must be carried out by trained people, under the correct conditions and using the equipment described in “Procedure for Evaluating Accuracy and Precision of Gilson Pipettes”. For more details contact your Gilson distributor, who can help you to implement these pipette checking procedures or to build up your own procedures.

Users should establish a routine for testing their pipettes at regular intervals, taking into account the following factors: frequency of use (see cycle counters), the nature and accuracy requirements of the liquids being pipetted, the number of operators using the pipette, and the number of cycles performed each time the pipette is used. Because Pipetman Ultra Multichannel is designed with GLP in mind, you may read the cycle counters after switching on the pipette.

Procedure (Gravimetric Test)

Use a balance to measure the mass of the specified volume of water. The balance (which must be more accurate than the pipette) must be at the sensitivity specified in the Specifications Table.

Take 10 measurements from the first channel (1) and 10 from the last channel (8 or 12). Calculate the mean volume from the 20 measurements.

For example, for an Ultra 8x300 the recalibration volume is 60 μL . You set the LCD to show 60 μL , but you calculate a mean volume of 58 μL ; a mean error of -2 μL . Reset the pipette to show: Recalibration Volume *minus* Mean Error, in this example $60 - (-2) = 62 \mu\text{L}$.

Open the battery compartment, and plug in the user-calibration tool (as shown) to reset the displayed volume to 60 μL .

 *The LCD will show RECAL in the volume setting window. This indicates that the factory calibration has been modified. To remove the RECAL sign and obtain a “factory” calibration, send the pipette back to your Gilson distributor.*

Remove the user-calibration tool, close the battery compartment, and calculate the accuracy as described in “Procedure for Evaluating Accuracy and Precision of Gilson Pipettes”, which is a more exhaustive gravimetric test for determining accuracy and precision.



16 - SPECIFICATIONS (MAXIMUM PERMISSIBLE ERRORS)

These specifications are obtained in the forward mode, using a gravimetric method with the temperature of the distilled water stabilized at $21.5 \pm 1.5^{\circ}\text{C}$.

Model	Volume (μL)	Accuracy (systematic error)		Precision (random error)	
		Absolute μL	Relative %	Absolute μL	Relative SD %
8x20 and 12x20	Min 20	± 0.20 ± 0.40	± 10.0 ± 2.0	≤ 0.08 ≤ 0.20	≤ 1.0 ≤ 1.0
8x300 and 12x300	Min 100 300	± 0.70 ± 1.00 ± 3.00	± 3.5 ± 1.0 ± 1.0	≤ 0.35 ≤ 1.00 ≤ 3.00	≤ 1.75 ≤ 1.0 ≤ 1.0
Model	User Adjustment Volume (μL)	Balance Sensitivity (g)		Diamond Tips	
8x20 and 12x20	2	10^{-6}		DL10	
8x300 and 12x300	60	10^{-5}		D300	

Performance Tests

Each pipette is inspected and validated according to the Gilson Quality Assurance System. Based on extensive historical data, manufacturing conditions and expertise, and in compliance with ISO standards relative to statistical process control, the assurance level of this instrument performing to specifications is 99.8%. Specifications rely on the quality and consistency for the whole pipetting system; they are guaranteed only when the pipette is used with Gilson Diamond Tips.

PIPETMAN® *Ultra* *Multichannel*

ERRATUM

Please note that the table in Chapter 16 “Specifications” of the Pipetman Ultra Multichannel User’s Guide (LT801462/B) is not complete.

The following table should be used for future reference.

Model (Reference)	Volume (μL)	Maximum Permissible Errors			
		Gilson		ISO 8655	
		Systematic error (μL)	Random error (μL)	Systematic error (μL)	Random error (μL)
8x20 (F21040) and	Min. 1	± 0.10	≤ 0.08	± 0.40	≤ 0.20
	2	± 0.10	≤ 0.08	± 0.40	≤ 0.20
12x20 (F21041) Max	10	± 0.20	≤ 0.10	± 0.40	≤ 0.20
	20	± 0.40	≤ 0.20	± 0.40	≤ 0.20
8x300 (F21042) and	Min. 20	± 1.00	≤ 0.35	± 8.00	≤ 3.00
	30	± 1.00	≤ 0.45	± 8.00	≤ 3.00
12x300 (F21043) Max	150	± 1.50	≤ 1.50	± 8.00	≤ 3.00
	300	± 3.00	≤ 3.00	± 8.00	≤ 3.00

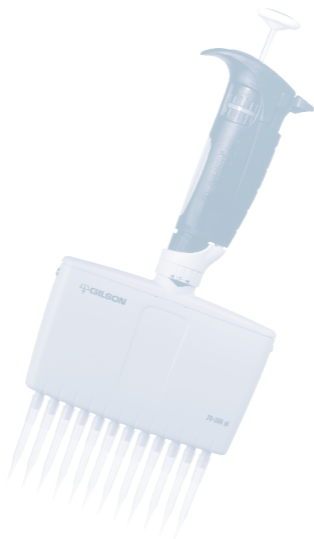

17 - SPARE PARTS

Description	8x20	12x20
A Push-button	F2073052	F2073152
C Cover-ejector	F2073059	F2073159
E Piston assembly	F2073064	
K Airtightness Kit	F2073065	
F Tip-holder assembly	F2073063	
R Reassembly tool	F2073001	
W Wire clip	F207306407	
L Lubricant	F2070902	
N Plastic window	F2072102	
M Cover (battery compartment)	F2072107	
H1 Battery	F20710	
H2 Battery holder	F2070158	
X Recalibration (User Adjustment) tool	F20751	

Description	8x300	12x300
A Push-button	F2073252	F2073352
C Cover-ejector	F2073259	F2073359
E Piston assembly	F2073264	
K Airtightness Kit	F2073265	
F Tip-holder assembly	F2073263	
R Reassembly tool	F2073201	
W Wire clip	F207306407	
L Lubricant	F2070902	
N Plastic window	F2072102	
M Cover (battery compartment)	F2072107	
H1 Battery	F20710	
H2 Battery holder	F2070158	
X Recalibration (User Adjustment) tool	F20751	

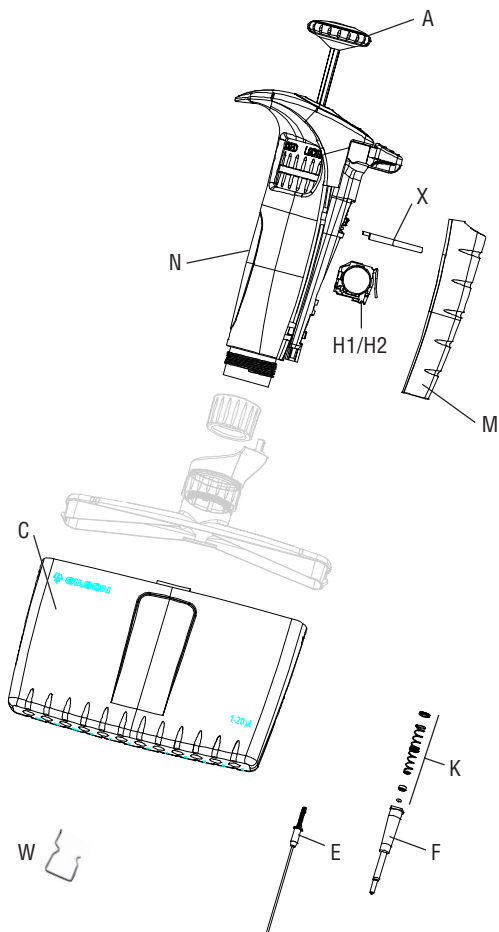

1) The airtightness kit (K) include the following items:

- Locking-clip,
- Spring,
- Seal-holder,
- Seal (O-ring).

2) The tip-holder assembly (F) includes the above items fitted into the tip-holder.

NOTES

LT801462/A - ©2002 Gilson SAS All right reserved November 2002
English Printed in France



World Headquarters

Gilson, Inc.

3000 W. Beltline Hwy., P. O. Box 620027, Middleton, WI 53562-0027, USA
Telephone: (1) 800-445-7661 or (1) 608-836-1551 • Fax: (1) 608-831-4451

Gilson SAS

19 avenue des Entrepreneurs, B. P. 145, 95400 Villiers-le-Bel, France
Telephone: (33) 1-34-29-50-00 • Fax: (33) 1-34-29-50-20