

Pipet-Lite™ XLS™

Manual Pipettes with RFID

Single-channel



Multichannel



Adjustable Spacer



Pipet-Lite™ XLS

Manual Pipettes with RFID

- **Single channel models with LTS or with traditional universal -fit shafts**
- **Multichannel models with LTS**
- **Adjustable spacer multichannel models with LTS**
- **RFID enabled. all models**

Table of Contents

1.1	Introduction	3
1.2	Setting Volume	4
1.3	Tip Selection and Mounting.....	6
1.4	Tip Immersion Depth.....	6
1.5	Operation	7
1.6	Autoclaving	7
1.7	Tip Ejector Arm Removal	8
1.8	Pipet-Lite XLS Storage	8
1.9	Troubleshooting	8
1.10	Service, Calibration, and Repair	9
1.11	Specifications	9
1.12	Replacement Parts	11
2.1	RFID Operation.....	12
3.1	Pipet-Lite XLS Multichannel.....	14
4.1	Pipet-Lite XLS Adjustable-Spacer	16

Contents of Pipet-Lite XLS box

- Pipet-Lite XLS model as ordered
- CD-ROM containing this manual and trial RFID software
- Sample Tips
- Conformance Certificate / Warranty Card

If any item is missing please call 800-472-4646 in the US, or contact your local MT office or distributor.

Rainin, Pipet-Lite, XLS, LTS, LiteTouch, Hang-Ups are trademarks of Rainin Instrument, LLC. Pipet-Lite pipettes are manufactured under U.S. Patent Nos. 5,614,153; 5,700,959; and 5,849,248. For use under U.S. patents 6,168,761 B1; 6,171,553 B1; and D426,643.

©2010 Rainin Instrument, LLC. No part of this manual may be copied without the express written permission of Rainin Instrument, LLC.

1.1 Introduction

Rainin's new Pipet-Lite XLS is based upon Pipet-Lite and incorporates several new features to further improve ergonomics while maintaining high accuracy and performance. Pipet-Lite XLS is available in several versions outlined below. This manual will describe all models.

Single-channel

11 models for volumes from 0.1 μl to 20 ml

Multichannel

12 models for volumes from 1 μl to 1200 μl , including 8 and 12 channels

Adjustable-spacer

5 models for volumes from 5 μl to 1200 μl including 6 and 8 channels, with nozzle spacing adjustable from 9-19 or 9-14 mm

Spring forces in the Pipet-Lite XLS are reduced even further over the already low forces used in Pipet-Lite: with the low-drag seals, new contoured handle with fingerhook, the pipette is designed for maximum comfort and enhanced performance, not compromised by fatigue over long pipetting days.

A magnet is used to help locate and hold Pipet-Lite XLS piston in the zero or home position, which defines the starting point for the pipette cycle and allows the use of lighter aspiration and blowout springs, reducing forces on the operator's thumb.

In models with LTS™ shafts (L-model single channels, all multichannels and adjustable spacers), the patented LTS LiteTouch™ Tip Ejection System reduces tip ejection forces by up to 85% in the single-channel L models, and provides absolutely consistent sample pickup across all channels in multichannel models, as well as reducing tip ejection force.

Finally, all Pipet-Lite XLS models contain an RFID (radio-frequency identification) for facilitating calibration management when using the optional RFID reader and Lab-X™ Direct Pipette-Scan™ software. Using the RFID is described after the single-channel section.

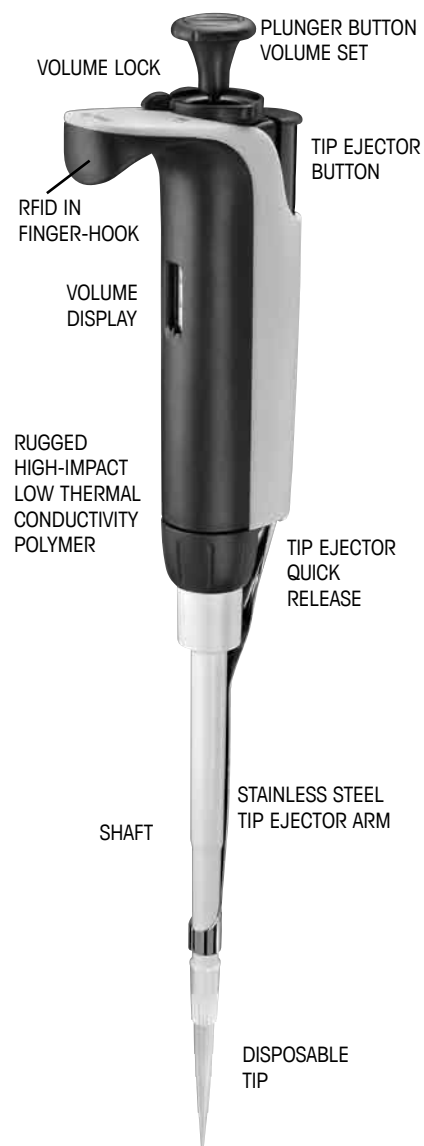

Figure 1: Pipet-Lite XLS

1.2 Setting Volume

1. Turn the volume lock lever to the “unlock” position so the volume setting mechanism is unlocked and free to turn. See left image in Figure 2.



Figure 2: Volume Lock Control

2. With the mechanism unlocked, orient Pipet-Lite XLS so you are looking at the volume indicator, then rotate the plunger button to change volume – counter-clockwise to increase, and clockwise to decrease volume.

2 μ l	10 μ l	20 μ l	100 μ l	200 μ l	300 μ l	1000 μ l	2000 μ l	5000 μ l	10 ml	20 ml
1	0	1	0	1	2	0	1	4	0	1
2	7	2	7	2	2	7	2	2	7	2
5	5	5	5	5	5	5	5	5	5	5
1.25 μ l	7.5 μ l	12.5 μ l	75 μ l	125 μ l	225 μ l	0.75 ml	1.25 ml	4.25 ml	7.5 ml	12.5 ml

Figure 3: Volume Indicator by Pipette Model

Read the volume indicator from the top down:

2–20 μ L: Black digits indicates μ l. Red digits – tenths, hundredths of μ l.

100–300 μ l: All digits black – μ l.

1000–5000 μ l: red digit – ml. Black digits– tenths, hundredths of ml.

10 ml and 20 ml: Red digit – ml. Black digits – tenths of ml.

3. To eliminate errors due to mechanical backlash: when setting the desired volume, first turn the knob 1/3 turn above the desired volume. Then turn the knob slowly clockwise until the desired volume is displayed. Always dial down to the desired volume.
4. Turn the volume lock to the “lock” position (Fig. 2 above) to prevent changes to the volume setting. Some volumes for the 200 μ L model are shown in Figure 4.

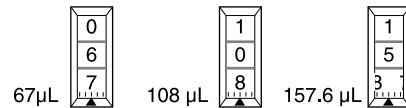

Figure 4: Example volumes

Volume ranges and increments for each Pipet-Lite XLS model are shown below:

Single-Channel Pipet-Lite XLS

Volume	Adjustable Range μL	Recommended Range μL	Increment μL
2 μL	0 to 2	0.1 to 2	0.002
10 μL	0 to 10	0.5 to 10	0.02
20 μL	0 to 20	2 to 20	0.02
100 μL	0 to 100	10 to 100	0.2
200 μL	0 to 200	20 to 200	0.2
300 μL	0 to 300	20 to 300	0.5
1000 μL	0 to 1000	100 to 1000	2.0
2000 μL	0 to 2000	200 to 2000	2.0
5000 μL	0 to 5000	500 to 5000	5.0
10 mL	0 to 10 mL	1 mL to 10 mL	20.0
20 mL	0 to 20 mL	2 mL to 20 mL	20.0

Multichannel and Adjustable-Spacers

Volume	Adjustable Range μL	Recommended Range μL	Increment μL
10 μL	0 to 10	0.5 to 10	0.02
20 μL	0 to 20	2 to 20	0.02
50 μL	0 to 50	5 to 50	0.05
100 μL	0 to 100	10 to 100	0.2
200 μL	0 to 200	20 to 200	0.2
300 μL	0 to 300	20 to 300	0.5
1200 μL	0 to 1200	100 to 1200	2.0

Filter

Single-Channel Pipet-Lite XLS 5000 μL , 10 mL, and 20 mL pipettes use a filter in the end of the shaft to help prevent liquid entering the shaft and contaminating the piston, should the plunger snap up during aspiration. Using a filter is recommended when pipetting large volumes. Replace the filter if it gets wet.

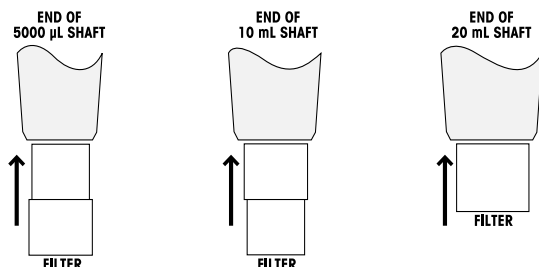

Figure 5: Filter orientation

The 5000 μL and 10 mL pipettes use the same filter, as shown in the diagram above:

5000 μL : small diameter into the shaft. 10 mL: large diameter into the shaft.

Filter part numbers are 6190-164 (pack of 100) and 6190-165 (pack of 1000).

The filter for the 20 mL model is a cylinder.

Part numbers: 6190-221 (pack of 100), 6190-222 (pack of 500).

1.3 Tip Selection and Mounting

Rainin pipettes and tips are designed together as a pipetting system, both in LTS and traditional versions. All Rainin tips are BioClean and totally inert, so you can be assured of the best pipetting results.

Pipet-Lite XLS pipettes are calibrated with Rainin tips, and performance to published specifications can only be guaranteed when Rainin tips are used.

To mount a tip, press the Pipet-Lite XLS shaft into the end of the tip with light force. With both LTS and traditional versions, the tip will seal properly on the shaft with minimal force — do not use more force than is required.

1.4 Tip Immersion Depth

The recommended depth for tip insertion into the sample for each model is shown below.

Nominal Volume	Volume Range	Immersion Depth
2 μL	0.1 - 2 μL	1-2 mm
10 μL	0.5 - 10 μL	1-2 mm
20 μL	2 - 20 μL	2 - 3 mm
100 μL	10 - 100 μL	2 - 3 mm
200 μL	20 - 200 μL	3 - 6 mm
300 μL	20 - 300 μL	3 - 6 mm
1000 μL	100 - 1000 μL	3 - 6 mm
2000 μL	200 - 2000 μL	3 - 6 mm
5000 μL	500 - 5000 μL	6 - 10 mm
10 mL	1 mL - 10 mL	6 - 10 mm
20 mL	2 mL - 20 mL	6 - 10 mm

Tip immersion depth is critical and should not be exceeded, or the volume measured may be inaccurate, possibly out of specification. The tip angle is also important – the pipette should always be used in a position within 20 degrees of vertical. See Figure 6 below.

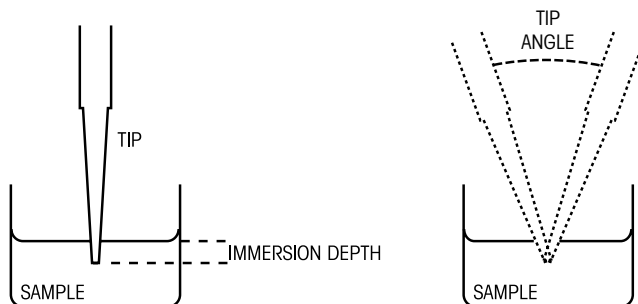

Figure 6: Tip Immersion Depth and Tip Angle

1.5 Operation

Before pipetting valuable samples, it is good to practice aspirating and dispensing water.

1. Set the desired volume as described on page 4.
2. Attach a new Rainin tip. Press the shaft into the tip with only sufficient force to make a good seal.
3. Press the plunger button to the first stop, and hold it in this position.

Aspiration:

1. Holding Pipet-Lite XLS vertically (or within 20° of vertical), place the tip into the sample to the proper depth and relax your thumb pressure on the plunger. The light piston spring will move the piston upward, aspirating sample. Do not let go of the plunger button, or the piston may snap up quickly, resulting in inaccurate measurement.
2. Pause for about 1 second (longer for macro-volume pipettes) to ensure that the full volume of sample is drawn into the tip.
3. Withdraw the tip from the sample. If any liquid remains on the outside of the tip, touch it off carefully onto a lint-free tissue, taking care not to touch the tip orifice.

Dispensing:

1. Touch the tip end against the side wall of the receiving vessel and press the plunger slowly, past the first stop, to blowout (bottom of stroke.)
Wait: 1 second for 2–300 µL volumes, 1-2 seconds for 1000 µL and larger.
(For viscous solutions pause before blowout.)
2. Still holding the plunger, withdraw the tip, sliding it along the wall of the vessel. Release the plunger.
3. Press the tip ejector button lightly to discard the tip. Use a new tip for each sample to prevent carry-over. Repeat for the next pipetting cycle.

Pipetting Guidelines

Pipet-Lite XLS pipettes incorporate several features to enhance pipetting consistency.

You should also maintain:

1. Consistent pickup and dispense rhythm.
2. Consistent speed and smoothness when pipetting.
3. Consistent pressure on the plunger button at the first stop.
4. Consistent immersion depth. See Figure 6.
5. Pipette vertically, or within 20° of vertical.
6. Pre-rinse the tip twice by aspirating and dispensing sample before actual pickup.
7. Don't invert or lay the pipette flat with liquid in the tip.

More information on Good Pipetting Technique, including a Lab Poster, can be found on the Rainin and MT websites: www.rainin.com or www.mt.com/rainin.

1.6 Autoclaving

Autoclavable parts of Pipet-Lite XLS are the shaft and the tip ejector: 121°C, 1 bar, 15-20 minutes.

DO NOT autoclave the complete pipette or any parts other than the shaft and the tip ejector.

1.7 Tip Ejector Arm Removal

Three types of tip ejector are used and all types can be removed with minimum effort - do not use force.

For models up to 2000 μL , press in the quick-release tabs on the ejector arm and pull the ejector down.

For 5000 μL and 10 mL models, grasp the top of the ejector arm and pull outward then downward.

For the 20 mL model, pull off the lower part of the ejector arm; the upper part stays in place. (Replace by aligning the rod with the hole in the upper part and pressing firmly.)

To replace the ejector arm (except 20 mL), insert the shaft through the large opening, align the top with the tip ejector push-rod, and push until the ejector arm snaps in place.

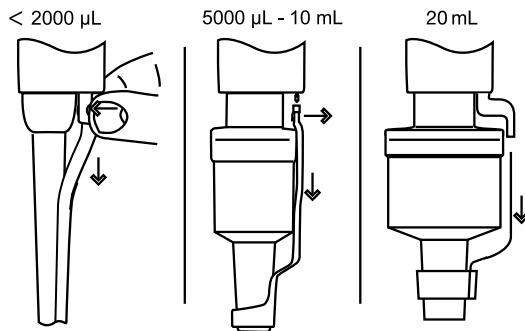

Figure 7: Removing Tip Ejector Arm

1.8 Pipet-Lite XLS Storage

After use, store the pipette in a clean safe place. Pipet-Lite XLS is a precision instrument and should be treated with the level of care appropriate for laboratory instrumentation. Three types of hanger are available to hold your Pipet-Lite XLS conveniently when not in use.

CR-7: Free-standing carousel holds seven pipettes.

HU-M3: Set of three individual magnetic Hang-Ups™ for mounting on ferrous surfaces.

HU-S3: Three Hang-Ups attached to a clamp which fits onto a shelf

1.9 Troubleshooting

Problem	Possible Cause	Suggested Remedy
Leaks, inaccuracy	Loose shaft	Tighten coupling nut by hand.
	Worn seal or o-ring – pipette volumes < 2000 µl	Replace seal and o-ring.
	Worn o-ring or (for pipette volumes 5000 µl, 10ml, 20 ml) insufficient grease seal on these pipettes	Replace o-ring and – for 5000 µl, 10 ml and 20 ml pipettes only – apply small amount of grease.
	Cracked or split shaft.	Replace shaft. Check piston is not bent. If bent, call Rainin service for a new piston. 800-543-4030 in the US.
Rough, jerky, or sticky plunger movement	Sample splash inside mechanism leading to staining and or corrosion.	Remove tip ejector arm, remove shaft and check piston. If piston is corroded or stained, call Rainin service for a new piston. 800-543-4030 in the US.

When removing the shaft from the pipette body, make sure the spring, seal and o-ring do not detach from the piston, especially on the smaller models. Be careful not to bend the piston on these small models. Recalibration of Pipet-Lite XLS is only required when the piston is replaced.

1.10 Service, Calibration and Repair

It is recommended to use only genuine Rainin replacement parts such as seals, o-rings, and shafts. It is NOT necessary to recalibrate the pipette after changing the seal, o-ring, or shaft. Recalibration of the pipette is only necessary when the piston is replaced, and should be done only by qualified factory-trained personnel in a Rainin approved facility.

For pipettes under warranty, please note that the warranty will be voided if the pipette has been damaged as a result of physical or chemical abuse, or if the pipette has been repaired or recalibrated by any service facility which is not authorized by Rainin.

In the US, call 800-543-4030 for service.

Service is also available outside the US. See www.mt.com/rainin for more information.

Acids and Corrosives

Extensive contact with corrosive fumes may result in premature seal wear and damage to the piston. Exposure of the internal components to corrosive aerosols and fumes may be reduced by using Rainin tips with aerosol barrier filters.

After using concentrated acids or corrosive solutions, you can disassemble Pipet-Lite XLS and inspect and clean the piston assembly, shaft and seal / o-ring with distilled water. Use extreme care on the 2 µl and 10 µl models to avoid damaging the small diameter piston, or losing small items such as seals. Dry all components thoroughly and reassemble.

1.11 Specifications

These manufacturer's specifications should be used as guidelines when establishing your own performance specification.

Model	Volume μL	Increment μL	Accuracy		Precision	
			%	μL (±)	%	μL (≤)
2 μL	0.2	0.002	12.0	0.024	6.0	0.012
	1.0		2.7	0.027	1.3	0.013
	2.0		1.5	0.030	0.7	0.014
10 μL	1.0	0.02	2.5	0.025	1.2	0.012
	5.0		1.5	0.075	0.6	0.03
	10.0		1.0	0.1	0.4	0.04
20 μL	2	0.02	7.5	0.15	2.0	0.04
	10		1.5	0.15	0.5	0.05
	20		1.0	0.2	0.3	0.06
* 50 μL	5	0.05	3.5	0.18	1.5	0.075
	25		1.2	0.3	0.4	0.1
	50		0.8	0.4	0.2	0.1
100 μL	10	0.2	3.5	0.35	1.0	0.1
	50		0.8	0.4	0.24	0.12
	100		0.8	0.8	0.15	0.15
200 μL	20	0.2	2.5	0.5	1.0	0.2
	100		0.8	0.8	0.25	0.25
	200		0.8	1.6	0.15	0.3
300 μL	30	0.5	2.5	0.75	1.0	0.3
	150		0.8	1.2	0.25	0.375
	300		0.8	2.4	0.15	0.45
1000 μL	100	2	3.0	3.0	0.6	0.6
	500		0.8	4.0	0.2	1.0
	1000		0.8	8.0	0.15	1.5
* 1200 μL	100	2	3.6	3.6	0.6	0.6
	600		0.8	4.8	0.2	1.2
	1200		0.8	9.6	0.15	1.8
2000 μL	200	2	3.0	6.0	0.6	1.2
	1000		0.8	8.0	0.2	2.0
	2000		0.8	16.0	0.12	2.4
5000 μL	500	5	2.4	12.0	0.6	3.0
	2500		0.6	15.0	0.2	5.0
	5000		0.6	30.0	0.16	8.0
10 mL	1 mL	20	5.0	50.0	0.6	6.0
	5 mL		1.0	50.0	0.2	10.0
	10 mL		0.6	60.0	0.16	16.0
20 mL	2 mL	20	5.0	100.0	0.6	12.0
	10 mL		1.0	100.0	0.2	20.0
	20 mL		0.6	120.0	0.16	32.0

Specifications are subject to change without notice.

* Multichannel models only in these volume ranges

1.12 Replacement Parts

The commonly-replaced parts are shown here for each volume range for Pipet-Lite XLS, single-channel LTS and universal-fit models.

The images next to the tables represent the 200 µl model (top) and the 10 mL model (bottom) – other models are similar.

Models <2000 µl	Seal	O-Ring	Shaft	Tip Ejector Arm
L-2 XLS	6200-131	6200-132	6202-063	6202-071
L-10 XLS	6200-138	6200-139	6202-064	6202-071
L-20 XLS	6200-143	6200-170	6202-065	6202-071
L-100 XLS	6200-150	6200-151	6202-066	6202-073
L-200 XLS	6200-154	6200-155	6202-067	6202-073
L-300 XLS	6200-415	6200-414	6202-425	6200-419
L-1000 XLS	6200-161	6200-162	6202-068	6202-074
L-2000 XLS	6200-166	6200-167	6202-214	6200-168
SL-2 XLS	6200-131	6200-132	6200-134	6200-133
SL-10 XLS	6200-138	6200-139	6200-140	6200-133
SL-20 XLS	6200-143	6200-170	6200-145	6200-144
SL-100 XLS	6200-150	6200-151	6200-147	6200-148
SL-200 XLS	6200-154	6200-155	6200-157	6200-156
SL-300 XLS	6200-415	6200-414	6200-413	6200-419
SL-1000 XLS	6200-161	6200-162	6200-160	6200-163
SL-2000 XLS	6200-166	6200-167	6200-169	6200-168

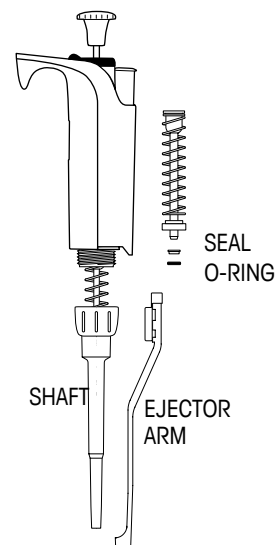

Models >5000 µl	Piston O-Ring	Cylinder O-Ring	Shaft	Tip Ejector Arm
L-5000 XLS	6200-363	6200-364	6202-222	6200-373
L-10ML XLS	6200-369	6200-370	6202-223	6200-374
L-20ML XLS	6202-299	6202-300	6202-302	6202-298
SL-5000 XLS	6200-363	6200-364	6200-362	6200-373
SL-10ML XLS	6200-369	6200-370	6200-368	6200-374

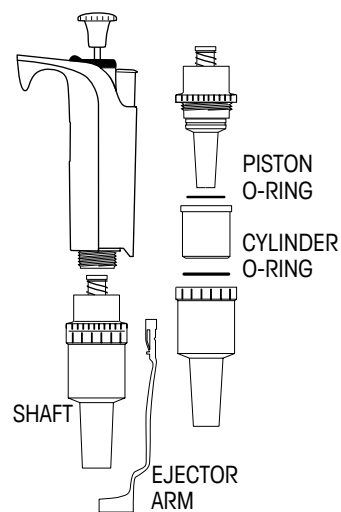

Figure 8: Common Replacement Parts
Top < 2000 µL Bottom > 5000 µL

2.1 RFID (Radio Frequency Identification Device)

All Pipet-Lite XLS models incorporate a passive RFID tag in the finger-hook, containing unique information about the pipette, including model type, serial number, RFID UID and service calibration information. The RFID tag can be wirelessly linked with optional reader and software to facilitate querying calibration tracking and service reminders. The RFID tag has negligible weight with no effect on precision or accuracy. It operates only when read by the RFID reader and the below-mentioned software.

Optional Rainin RFID Reader

Rainin recommends a specific Rainin RFID reader that interfaces with a PC's USB port. Rainin does not recommend any other RFID reader. Using the Rainin RFID reader, information can be written to the Pipette's RFID tag in the same consistent way as it is read from the RFID tag. The Rainin RFID Reader can be used with any Rainin RFID enabled Pipet-Lite XLS; but needs appropriate software for it to work. The estimated range of operation of the RFID reader is up to 5 cm.

How to read the Rainin RFID Reader LEDs (Light-emitting diodes)

LEDs	Description
Yellow & Green	Reader powers up in this state. Reverts to this state when application is stopped or a plug-in is disabled.
Yellow	Reader has detected a pipette. Keep pipette close to reader until LED changes to Green (or Red).
Green	When application first starts, Green LED indicates the device is ready. After all data is read from a pipette held close to the reader, Green LED lights up.
Red	Reader failed to read or write. Try scanning the pipet again, if not restart software.
Yellow & Red	Data written to the pipette does not compare with data read back from the pipette.

Optional LabX™ Direct Pipette-Scan™ Software

Supplied on the same CD as this manual is a trial version of the Lab-X Direct Pipette-Scan software. A full version is also available for purchase. Supported PC Operating Systems: Microsoft Windows XP/Vista & Windows 7. Users can select any of the following languages: Chinese (Simplified), Czech, Danish, English, French, German, Hungarian, Italian, Japanese, Korean, Norwegian, Polish, Russian, Spanish, Swedish.

Operation Overview

An optional RFID Kit is available for purchase from Rainin. The RFID Kit contains the Rainin recommended RFID reader and the LabX Direct Pipette-Scan software. Once the Rainin RFID reader is connected by USB to your PC, and the software is configured and running, operation is simple.

Simply place the head of the pipette in the recommended position as shown on the Rainin RFID reader, hold it steady for a few seconds to scan the pipette's RFID tag and read the pipette's information stored in its RFID tag into the software.



Figure 9
Rainin RFID Reader

Read-only fields from the Pipette's RFID-Tag

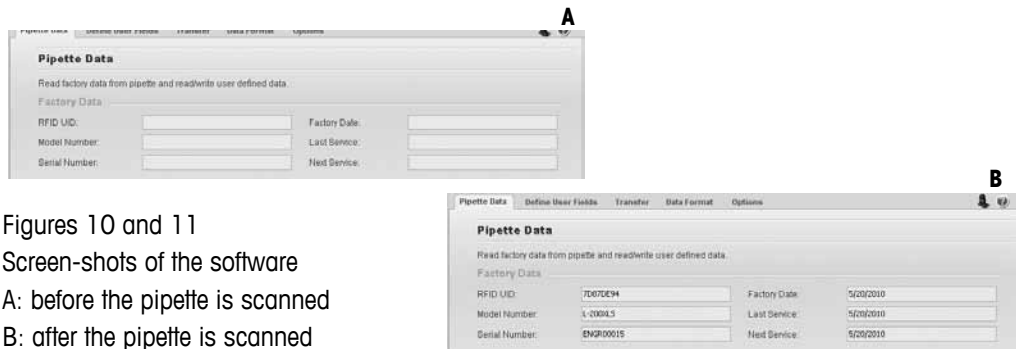

Figures 10 and 11

Screen-shots of the software

A: before the pipette is scanned

B: after the pipette is scanned

The software shows the read-only data fields programmed into each pipette's RFID tag before it leaves the factory. These fields can ONLY be modified by Rainin when the pipette is manufactured or updated when sent in for service. The read-only fields include the RFID UID, Model Number, Serial Number, Factory Date, Last Service Date and Next Service date. For QC or workflow purposes, multiple RFID enabled pipettes can be scanned sequentially.

Writing Data to the RFID-Tag's custom fields

In addition there are writable fields available on each pipette's RFID tag that can be chosen by the users to customize their pipettes so as to standardize their unique workflow(s). Each customer is free to customize and/or standardize the software to suit their unique workflow(s). Any such writing operation requires the Rainin RFID reader and the LabX Direct Pipette-Scan software. Refer to the software help file for more instructions.

What RFID / LabX Direct Pipette-Scan Software can do

The LabX Direct Pipette-Scan software is flexible to help you customize your workflow. Customers can standardize their departments on the new Pipet-Lite XLS pipettes and Rainin RFID reader with LabX Direct Pipette-Scan software system based workflow and calibration check system. This system helps simplify the work of Quality Compliance Specialists. It shortens the calibration check cycle, returning pipettes back to active lab use faster. In addition, data can also be written to the Pipette's RFID tag by configuring the custom fields in the LabX Direct Pipette-Scan software and advanced workflows can be defined for your custom settings.

What RFID does not do:

- Does not protect against misplacement, theft, or provide pipette's location information
- Does not protect against erroneous data input
- Does not replace calibration stickers for businesses or displace QC professionals
- Does not validate your workflow. The validation of the workflow and CFR Part 11 regulatory compliance remains the responsibility of the customer.

3.1 Pipet-Lite XLS Multichannel Pipettes 8 and 12-channel models

Introduction

Pipet-Lite XLS multichannel pipettes are based on the Pipet-Lite XLS single-channel pipette and use the patented LTS LiteTouch Tip Ejection System.

Two versions of the Multichannel Pipet-Lite XLS are available: 8-channel and 12-channel. An 8-channel version is shown in Figure 12.

The 8- and 12-channel models are available in 6 volume ranges:

- 0.5 -10 μL ,
- 2-20 μL
- 5-50 μL ,
- 20-200 μL
- 20-300 μL ,
- 100-1200 μL .

Tip Selection

Pipet-Lite XLS multichannel pipettes use Rainin LTS tips.

L8-10, L8-20, L12-10, L12-20: 20 μL LTS tips

L8-50, L12-50, L8-200, L12-200: 250 μL LTS tips

L8-300, L12-300: 300 μL LTS tips

L8-1200, L12-1200: 1200 μL LTS tips (recommended) or 1000 μL LTS tips – pick up 1200 μL (except with filter)

LTS tips have a cylindrical cross-section with a well-defined seal ring, thin wall, and positive stop. They seal properly on the shaft and cannot be jammed or forced too far onto the shaft nozzles, and provide absolutely consistent sample pickup across all channels.

Mounting LTS Tips: 8- and 12-channel

Mounting racked LTS tips on L8 and L12 pipettes is simple. First align the shaft nozzles into the row of tips, holding the pipette at an angle. (Figure 13A). Position the pipette upright and press the nozzles into the tips until the “positive stop” is reached. (Figure 13B). The tips are now mounted with proper sealing. You do not need to hand-tighten, use heavy pressure, or “rock” the nozzles onto the tips to obtain a good seal.



Figure 12: Pipet-Lite XLS Multichannel Pipette

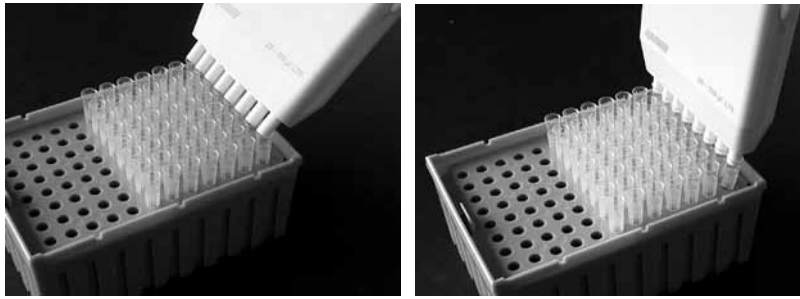

Figure 13: Mounting racked LTS Tips, L8 and L12

Tip Immersion Depth

The recommended depth for tip insertion is shown in the table below.

Pipet-Lite XLS Model

L8-10, L12-10 L8-20, L12-20

L8-200, L12-200, L8-300, L12-300, L8-1200, L12-1200

Immersion Depth

2 - 3 mm

3 - 6 mm

Positioning the Liquid End Manifold

The liquid end manifold can be rotated to any angle for convenience when filling plates. You do not need to loosen the coupling nut.

4.1 Pipet-Lite XLS Multichannel Pipette with Adjustable Spacing 6 and 8-channel models

Introduction

Pipet-Lite XLS Adjustable-Spacer multichannel pipettes are based on Pipet-Lite XLS single-channel pipettes, and operate in the same way.

Two versions of the Pipet-Lite XLS Adjustable-Spacer pipette are available: 6-channel (LA6) and 8-channel (LA8), with nozzle spacing adjustment ranges shown below:

6-channel	9 mm to approx. 19 mm
8-channel	9 mm to approx. 14 mm

6- and 8-channel versions are available in the volume ranges: 20-300 μL and 100-1200 μL .

8-channel versions are also available in the 5-50 μL volume range.

Spacing Controls and Indicators

Nozzle spacing is changed with the use of two knurled knobs on either end of the liquid end manifold: the LIMITER knob and the SPACING ADJUSTMENT knob, shown in Figure 14.

The LIMITER knob (marked with the nozzle spacing range) sets the desired maximum spacing within the pipette's spacing range. A vertical arrow at the top of the knob on the liquid end manifold is the set point, shown in Figure 15.

When you have set the maximum spacing with the LIMITER knob, turn the SPACING adjustment knob to open the nozzle spacing to the set value. A scale on the liquid end manifold gives a visual reference of the set spacing. Simply line up the the leftmost nozzle with the scale on the manifold, as shown in Figure 15.



Figure 14: Pipet-Lite XLS Adjustable-Spacer Pipette

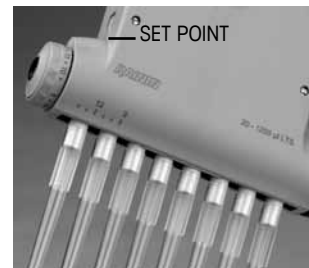

Figure 15: Liquid End Marks

The full range of adjustment for the eight-channel version is shown below in Figure 17. Nozzles are set to 9 mm spacing on the left and 14 mm spacing on the right.

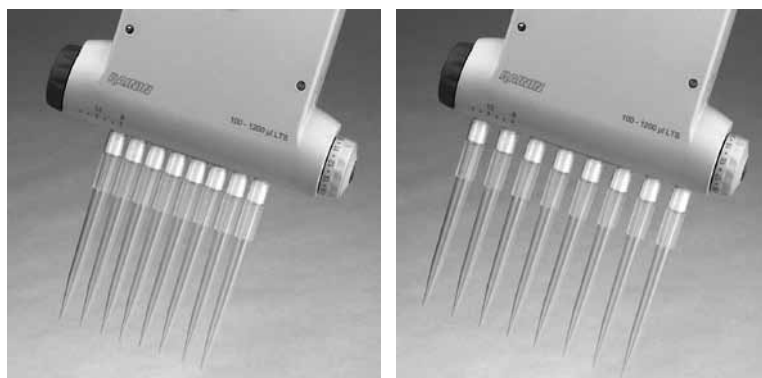

Figure 16: Nozzles: minimum spacing & maximum spacing

Tip Selection

Pipet-Lite multichannel pipettes must use Rainin LTS tips.

LA8-50: use 250 μ l LTS tips

LA6-300 and LA8-300: use 300 μ l LTS tips

LA6-1200 and LA8-1200: use 1200 μ l LTS tips (recommended) or 1000 μ l LTS tips – picks up 1200 μ l (except tips with filters)

LTS tips have a cylindrical cross-section with a well-defined seal ring, thin wall, and positive stop. They seal properly on the LTS nozzles and cannot be jammed or forced too far onto the nozzles.

Mounting LTS Tips

Mounting racked LTS tips onto LA6 and LA8 pipettes is simple.

Set the nozzle spacing to 9 mm (same as the spacing for racked tips) by rotating the dark grey SPACING ADJUSTMENT knob fully clockwise.

Align the nozzles into the row of tips, holding the pipette at a slight angle. (Figure 17 left).

Rotate the pipette upright and press the nozzles into the tips until the “positive stop” is reached.

The tips are now mounted with proper sealing. You do not need to hand-tighten, use heavy pressure, or “rock” the nozzles onto the tips to obtain a good seal. Withdraw the tips from the tip rack. (Figure 17 right)

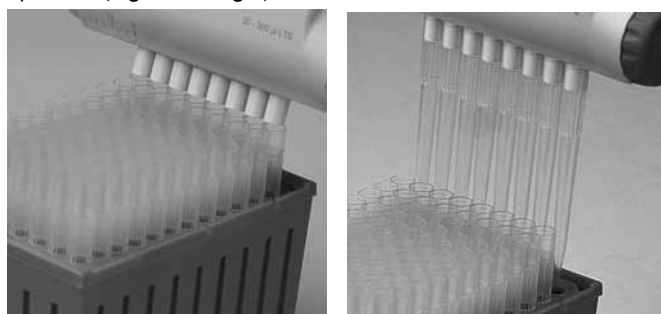

Figure 17: Mounting LTS Tips

Setting the Nozzle Spacing

With tips mounted on the nozzles, and before you begin to aspirate sample:

- If you know the spacing for the receiving wells or test-tube block, set this value on the LIMITER knob.
- If you do not know the spacing, hold the pipette so that the tip ends are above the centers of the wells or test-tube block into which you will dispense. Look at the scale on the liquid end manifold, and note where the marked nozzle aligns. Set this value on the LIMITER knob.
- If you accidentally over-extend the spacing, you can click the LIMITER knob to smaller values, stopping when the tip ends are aligned over the centers of the wells/test tubes.

Once the LIMITER knob has been set, spacing the nozzles properly is simple.

Just pick up sample, set the nozzle spacing by moving the SPACING ADJUSTMENT knob until it stops at the value set by the LIMITER knob, and dispense into the wells or test-tube block.

Tip Immersion Depth

Recommended depth for tip insertion for each Pipet-Lite XLS adjustable-nozzle model:

LA8-50: 2–3 mm

LA6-300, LA8-300, LA6-1200, LA8-1200: 3–6 mm

Operate the pipette within 20 degrees of vertical.

Tip Ejection

Simply press on the tip ejector button. All tips are ejected cleanly with minimal pressure on the thumb because of the progressive eject design built in to the liquid end manifold.

Positioning the Liquid End Manifold

The liquid end manifold can be rotated to any angle for convenience. You do not need to loosen the coupling nut.

www.rainin.com

For more information

Rainin Instrument, LLC.

7500 Edgewater Drive
Oakland, CA 94621
Sales +1 510 564-1600
Service +1 510 564 1600

Subject to technical changes
© 2010 Rainin Instrument LLC
Printed in USA 9920-386 Rev E
a METTLER TOLEDO Company